



INSTALLATION

L.E.D. DRIVING LIGHTS for GL 1800

2235

PARTS INCLUDED

- 1 Left L.E.D. Driving Light Assembly
- 1 Right L.E.D. Driving Light Assembly
- 1 Left Mounting Bracket
- 1 Right Mounting Bracket
- 1 Hardware Kit Containing
 - 4 M5 X 25mm Button Socket Cap Screws
 - 2 M5 X 0.8 X 40mm Phillips Pan Screws
 - 3 M6 X 40mm Socket Head Cap Screws
 - 3 M6 X 55mm Socket Head Cap Screws
 - 1 26mm Spacer
 - 1 4mm Spacer
 - 1 22mm Spacer
 - 1 20mm Spacer
 - 1 10mm Spacer
 - 1 6mm Spacer
 - 8 M5 Flat Washers
- 1 Adjuster Shim Kit Containing
 - 4 4mm Spacers
 - 4 2mm Spacers
 - 1 M6 X 45mm Socket Head Cap Screw
 - 1 M6 X 60mm Socket Head Cap Screw
 - 2 1" X 0.03" Compression Springs
 - 6 M6 Fender Washers
 - 6 Large Rubber Top Hats with Steel Bushings
 - 4 Small Rubber Top Hats with Steel Bushings
- 1 Switch with Harness
- 1 Relay with Harness

Please read and understand entire instructions before starting installation.

THANK YOU FOR CHOOSING KÜRYAKYN!

IN ORDER TO PROTECT YOU AND OTHERS FROM POSSIBLE INJURY AND/OR PROPERTY DAMAGE OR LOSS, PLEASE PAY CLOSE ATTENTION TO ALL INSTRUCTIONS, WARNINGS, CAUTIONS AND NOTICES REGARDING THE USE AND CARE OF THIS PRODUCT.

WARNING	THIS INDICATION ALERTS YOU TO THE FACT THAT IGNORING THE CONTENTS DESCRIBED HEREIN CAN RESULT IN POTENTIAL DEATH OR SERIOUS INJURY.
NOTICE	This indication alerts you to the fact that ignoring the contents described herein may negatively affect product performance and functionality.
CAUTION	This indication alerts you to the fact that ignoring the contents described herein can result in potential injury.

NOTICE

IF INSTALLING THIS PRODUCT FOR ANOTHER PARTY, PLEASE MAKE SURE THEY RECEIVE THIS COPY OF THE INSTALLATION INSTRUCTIONS SO THEY ARE AWARE OF THE IMPORTANT INFORMATION CONTAINED IN THEM.

TOOLS SUGGESTED

Set of Metric Hex Wrenches, Side Cutter, Phillips Screwdriver, Flat Blade Screwdriver

STRICTLY OBSERVE THE FOLLOWING GUIDELINES IN ORDER TO USE THE PRODUCT PROPERLY AND AVOID POTENTIALLY DANGEROUS ACCIDENTS.

CUSTOMER SERVICE

877.370.3604 (toll free)

INSTALLATION QUESTIONS

techsupport@kuryakyn.com
or call 715.247.2983

LIMITED WARRANTY

Kuryakyn warrants that any Kuryakyn products sold hereunder, shall be free of defects in materials and workmanship for a period of one (1) year from the date of purchase by the consumer excepting the following provisions:

- Kuryakyn shall have no obligation in the event the customer is unable to provide a receipt showing the date the customer purchased the product(s).
 - The product must be properly installed, maintained and operated under normal conditions.
- Kuryakyn makes no warranty, expressed or implied, with respect to any gold plated products.
 - Kuryakyn shall not be liable for any consequential and incidental damages, including labor and paint, resulting from failure of a Kuryakyn product, failure to deliver, delay in delivery, delivery in nonconforming condition, or for any breach of contract or duty between Kuryakyn and a customer.
- Kuryakyn products are often intended for use in specific applications. Kuryakyn makes no warranty if a Kuryakyn product is used in applications other than intended.
- Kuryakyn electrical products are warranted for one (1) year from the date of purchase by the consumer. L.E.D.'S contained in components of Kuryakyn products will be warranted for defects in materials and workmanship for 3 years from the date of purchase where as all other components shall be warranted for one(1) year. This includes, but is not limited to; control modules, wiring, chrome & other components.

- Kuryakyn makes no warranty of any kind in regard to other manufacturer's products distributed by Kuryakyn. Kuryakyn will pass on all warranties made by the manufacturer and where possible, will expedite the claim on behalf of the customer, but ultimately, responsibility for disposition of the warranty claim lies with the manufacturer.

ABOUT OUR CATALOG

For purchasing Kuryakyn® products, you can receive a complete catalog free of charge. Send the Proof-of-Purchase below with your address to: Kuryakyn, P.O. Box 339, Somerset, WI 54025. Please indicate either Accessories Catalog for Harley-Davidson® or GL & Metric Cruisers.

Be sure to ask your local dealer about other Kuryakyn® products, the motorcycle parts and accessories designed for riders by riders.

©2005 Kuryakyn USA® All Rights reserved.



kuryakyn.com

STEP 1 Read and understand all steps in the instructions before starting the installation. Park the motorcycle on a hard, level surface and turn off the ignition. Let cool.

WARNING YOU WILL BE WORKING AROUND THE ENGINE AND EXHAUST SYSTEM DURING INSTALLATION. ENSURE THAT THE ENGINE AND EXHAUST SYSTEM HAVE FULLY COOLED TO PREVENT INJURY.

CAUTION Avoid potential electrical shock! Disconnect the battery before starting this procedure.

NOTICE A factory service manual may be helpful in performing this installation. Do not attempt to perform this installation if you are not confident in your ability to complete all of the steps in the procedure; consult a trained technician.

NOTICE Avoid damage to the motorcycle. Protect painted surfaces with a soft cloth or blanket.

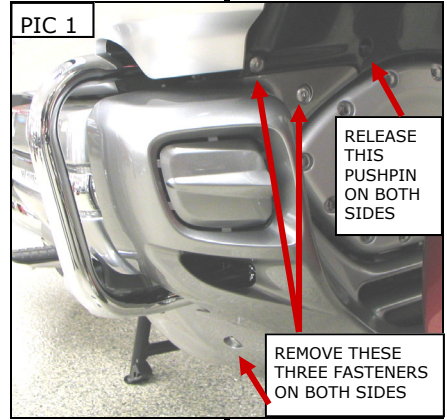

STEP 2 Disconnect the battery. Remove the six button socket screws (three on each side) that secure the lower cowl to the bike. There will also be two pushpins (one on each side) that will secure the lower cowl to the upper plastic shroud in front of the engine. PIC 1

STEP 3 Remove the lower cowl from the bike. Place the cowl on a soft cloth or blanket.

NOTE: It may be easier to remove the cowl by moving the handlebars from side to side.

STEP 4 Remove the stock black trim pieces from the bike and set aside for later installation. PIC 4

STEP 5 On the inside of the cowl, use a side cutter and cut all the connecting pieces that secure the cutout to the lower cowl. Repeat process on the opposite side. Try to cut the cutouts as flush as you can get with the side cutter. PIC 2.

STEP 6 Identify the left and right side (sitting on the bike) mounting brackets. They are stamped with R and L on the back and the adjuster screw will be on the bottom inside. PIC 3

NOTE: See Page 6 for exploded views of the mounting of the Left, FIG 2 and FIG 4, and Right, FIG 3 and FIG 5, Driving Lights. These will assist in the correct mounting of these lights.

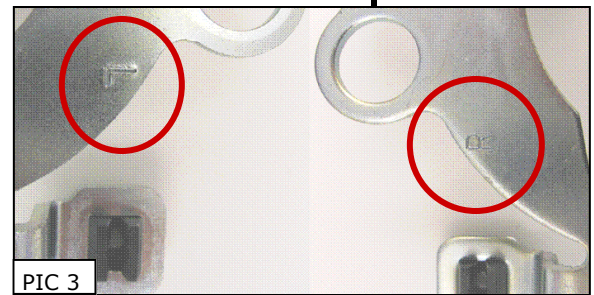
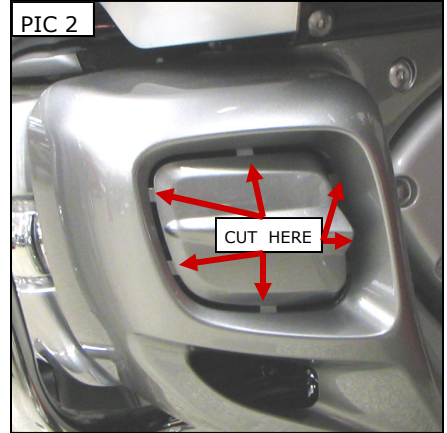

Procedure for mounting the Left (Clutch Side) Driving Light

STEP 7 Insert a large Top Hat Washer, from the back of the left mount, into the three rubber grommets on the mount. Place three of the M6 X 55mm Hex Head Cap Screws with the M6 flat washers through the rubber washer and out the backside of the mount. FIG 2

STEP 8 Holding the mount with all three bolts in place through the mount, take the 22mm spacer and place it over the top socket screw. Place the 26mm spacer over the middle socket screw. Place the 20mm spacer over the bottom socket screw. FIG 4 Place the stock trim piece over the top and bottom bolts and attach it to the bike. Tighten securely. PIC 4, FIG 2 **For optional lighting adjustment, see Step 32 and FIG 1, before mounting the bracket.**

STEP 9 Install two flat washers and the small spring on the Phillips Head Screw and attach it to the bottom inside corner of the light mount. PIC 4, FIG 4 Thread this in just a couple turns for now.

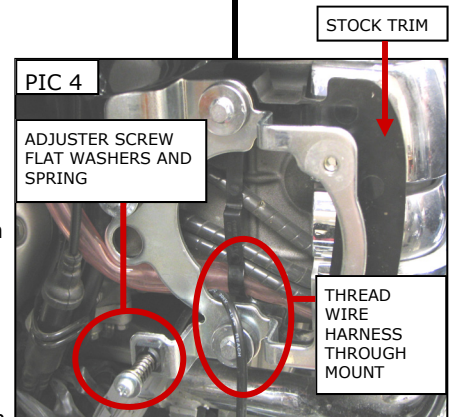

-cont.-

STEP 10 Thread the wire harness of the light through the opening in the mount. PIC 4 Insert a small Top Hat washer through the front of each of the two rubber grommets on the light holder. FIG 4 Insert a Socket Button Head Cap Screw and washer through each Top Hat, slide the notch on the bottom inside of the holder between the two flat washers on the Phillips adjuster screw PIC 5, and attach the light holder to the mount. PIC 5 and FIG 4

STEP 11 On the bike, locate a two pin grey female connectors with a brown w/ blue stripe and green wire. Remove the wire tie that secures the plug so it is easily accessible for the new driving light plug. Remove the dummy plug from the OEM connector. Connect the grey male connector from the light to the female connector on the bike. Tie up any slack with a supplied cable tie. PIC 6

NOTICE Secure all wiring from the newly installed and/or from existing parts, away from any moving parts, pinch points or extreme heat. Küryakyn WILL NOT issue a warranty on any electrical component that fails due to pinched, crimped, broken, abraded, melted or frayed wires.

NOTICE It is the installer's responsibility to ensure that all of the fasteners (including pre-assembled) are tightened before operation of the motorcycle. Küryakyn will not provide warranty coverage on products or components lost due to improper installation or lack of maintenance. Periodic inspection and maintenance are required on all fasteners.

Procedure for mounting the Right (Throttle Side) Driving Light

STEP 12 Insert a large Top Hat Washer, from the back of the right mount, into the three rubber grommets on the mount. Place three of the M6 X 40mm Socket Head Cap Screws with the M6 flat washers through the rubber washer and out the backside of the mount. FIG 3

STEP 13 Holding the mount with all three bolts in place through the mount, take the 6mm spacer and place it over the top socket screw. Place the 10mm spacer over the middle socket screw. Place the 4mm spacer over the bottom socket screw. FIG 3 Place the stock trim piece over this assembly and attach it to the bike. PIC 7 Tighten securely. **For optional lighting adjustment, see Step 32 and FIG 1, before mounting the bracket.**

STEP 14 Install two flat washers and the small spring on the Phillips Head Screw and attach it to the bottom inside corner of the light holder. FIG 5 Thread this in just a couple turns for now. PIC 7, FIG 5

STEP 15 Thread the wire harness of the light through the opening in the mount. PIC 7 Insert a small Top Hat washer through the front of each of the two rubber grommets on the light holder. FIG 5 Insert a Socket Button Head Cap Screw and washer through each Top Hat, slide the notch on the bottom inside of the holder between the two flat washers on the Phillips adjuster screw, and attach the light holder to the mount. PIC 5 and FIG 5

STEP 16 On the bike, locate a two pin grey female connectors with a brown w/ blue stripe and green wire. Remove the wire tie that secures the plug so it is easily accessible for the new driving light plug. Remove the dummy plug from the OEM connector. Connect the grey male connector from the light to the female connector on the bike. Tie up any slack with a supplied cable tie. PIC 8

NOTICE Secure all wiring from the newly installed and/or from existing parts, away from any moving parts, pinch points or extreme heat. Küryakyn WILL NOT issue a warranty on any electrical component that fails due to pinched, crimped, broken, abraded, melted or frayed wires.

STEP 17 Tighten all the hardware that secures both of the lights to the front of the bike.

-cont.-

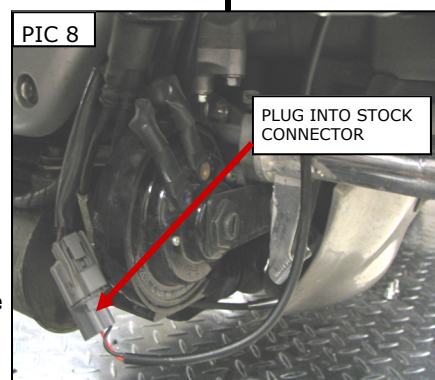
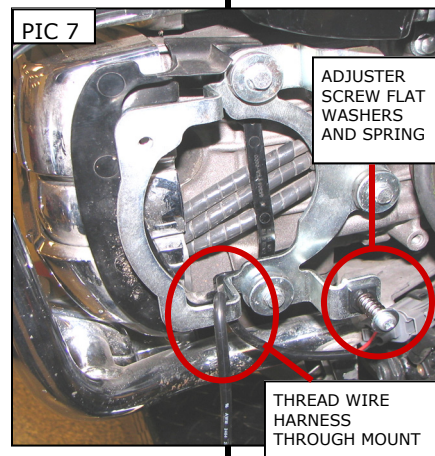
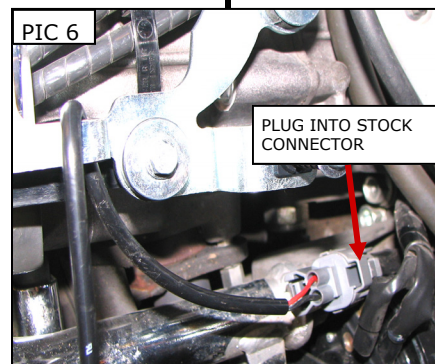
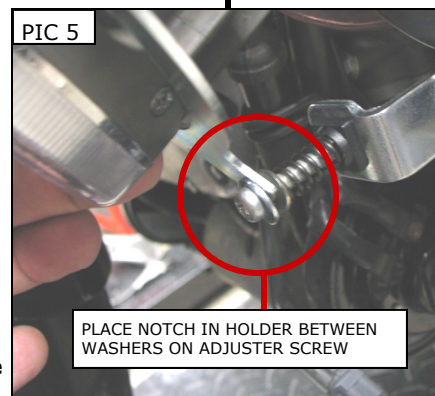

NOTICE

It is the installer's responsibility to ensure that all of the fasteners (including pre-assembled) are tightened before operation of the motorcycle. Kuryakyn will not provide warranty coverage on products or components lost due to improper installation or lack of maintenance. Periodic inspection and maintenance are required on all fasteners.

Kuryakyn®

STEP 18

With both lights mounted, make note of the driving light aiming process on Page 5. Notice the adjustment screws located on the bottom inside of the lights. Turn the bolts clockwise to pull the light down. Turn the bolt counter-clockwise to move it up.

Procedure for Mounting the Switch

STEP 19

Remove the outer trim piece from the left side of the bike by gently pulling upward on the trim. PIC 9 This will expose the mounting screws. You will want to remove the two fasteners shown in PIC 10.

STEP 20

Remove the glove compartment from the bike by pressing the four push-darts down with a Phillips screwdriver. Pushing these pins down will release the hold and allow you to fully remove the compartment. Set aside for later installation.

STEP 21

With the two fasteners removed, you will be able to slide the light control panel out by sliding the left side up and allowing the release tabs of the right side to fully release from the molding.

STEP 22

Remove the light control panel by releasing the wire harnesses located under the light panel and storage pocket.

STEP 23

Turn the light control panel over and remove the back cover. Remove the two screws for the left black plug, and remove the plug. PIC 10 (**F6B models will have two plugs at the bottom of the panel, these models will still use the LEFT plug as shown, PIC 10**) Set the stock screws aside. Install the new switch and secure it with the stock screws removed for the plug. PIC 11 The switch will only fit one way in the opening. Route the harness along the OEM harness and out the opening. PIC 12 Replace the back cover.

STEP 24

Secure the relay to the wire harness with a supplied cable tie to save room when installing the light control panel back on the bike.

STEP 25

On the bike, you will need to locate the 4-pin accessory connector that is located on the bottom right of the light control panel hole. The 4-pin connector will be inside of a rubber jacket. Slide the jacket back exposing the connector. The connector will have a blue wire with a black stripe, a brown wire with a white stripe, a green wire, and another brown wire with a blue stripe. PIC 13

STEP 26

Connect the new Driving Light Switch from the light control panel to the opposing plug located in Step 25.

STEP 27

Reinstall the light control panel by sliding the tabs in on the right and securing it with the stock fasteners removed in Step 19.

STEP 28

Reinstall the glove box by pushing the mounting push-darts to the "up" position and pushing them down flush after the glove box is into place. Tighten all the remaining bolts on the left hand side. In addition, reinstall the trim piece that was removed in Step 19.

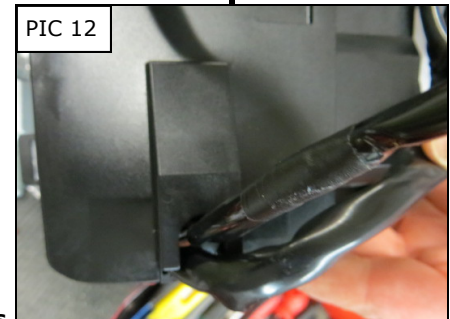
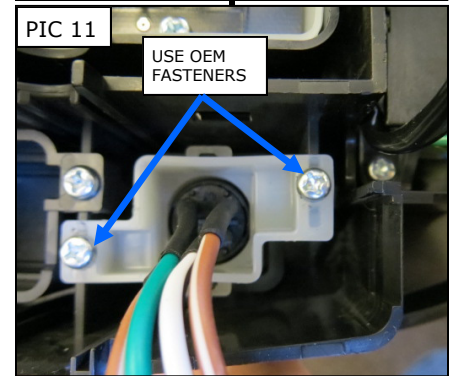
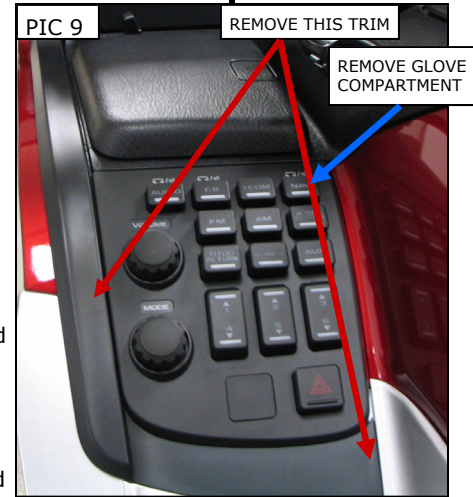

NOTICE

It is the installer's responsibility to ensure that all of the fasteners (including pre-assembled) are tightened before operation of the motorcycle. Kuryakyn will not provide warranty coverage on products or components lost due to improper installation or lack of maintenance. Periodic inspection and maintenance are required on all fasteners.

PAGE

4

-cont.-

L.E.D. DRIVING LIGHTS/GL 1800

INSTALLATION

STEP 29 Reconnect the battery and test the lights for proper operation.

NOTE: The new Driving Light Switch will always illuminate when the key is on regardless of whether the Driving Lights are on or off.

WARNING ENSURE PROPER LIGHT OPERATION BEFORE RIDING THE MOTORCYCLE. VISIBILITY IS A MAJOR CONCERN FOR MOTORCYCLISTS. A LIGHT MALFUNCTION COULD RESULT IN DEATH OR SERIOUS INJURY.

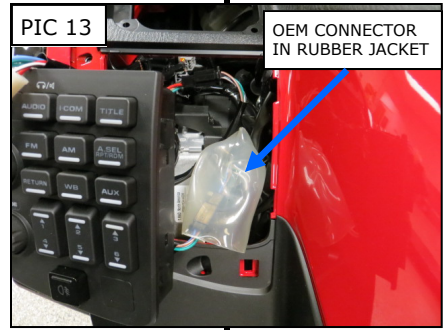

Procedure for Aiming the Driving Lights

STEP 30 Turn the adjustment screw clockwise until the spring is lightly bottomed out. PIC 10 After the adjuster screw is lightly bottomed, turn four full turns counter-clockwise. This is the default setting.

STEP 31 To adjust the light pattern down, turn the adjuster screw clockwise. To adjust the light pattern up, turn the adjuster screw counter-clockwise.

STEP 32 If you cannot get the lights adjusted to your desired position with the adjuster screw, you may use the provided shims and longer screws (the 45mm screw is used on the right side, the 60mm screw is used on the left) to move the base of the lights in the desired direction. Use FIG 3 to determine the placement of the shims and screws.

STEP 33 With the lights aimed properly, mount the lower light cowl with the mounting hardware and pushpins that were removed in Step 2, secure all hardware on the lower cowl.

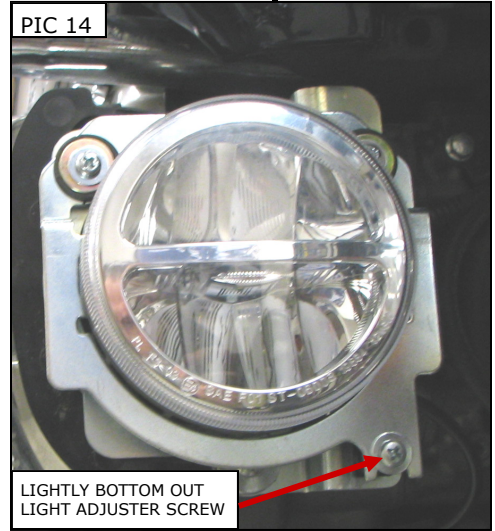

NOTICE It is the installer's responsibility to ensure that all of the fasteners (including pre-assembled) are tightened before operation of the motorcycle. Küryakyn will not provide warranty coverage on products or components lost due to improper installation or lack of maintenance. Periodic inspection and maintenance are required on all fasteners.

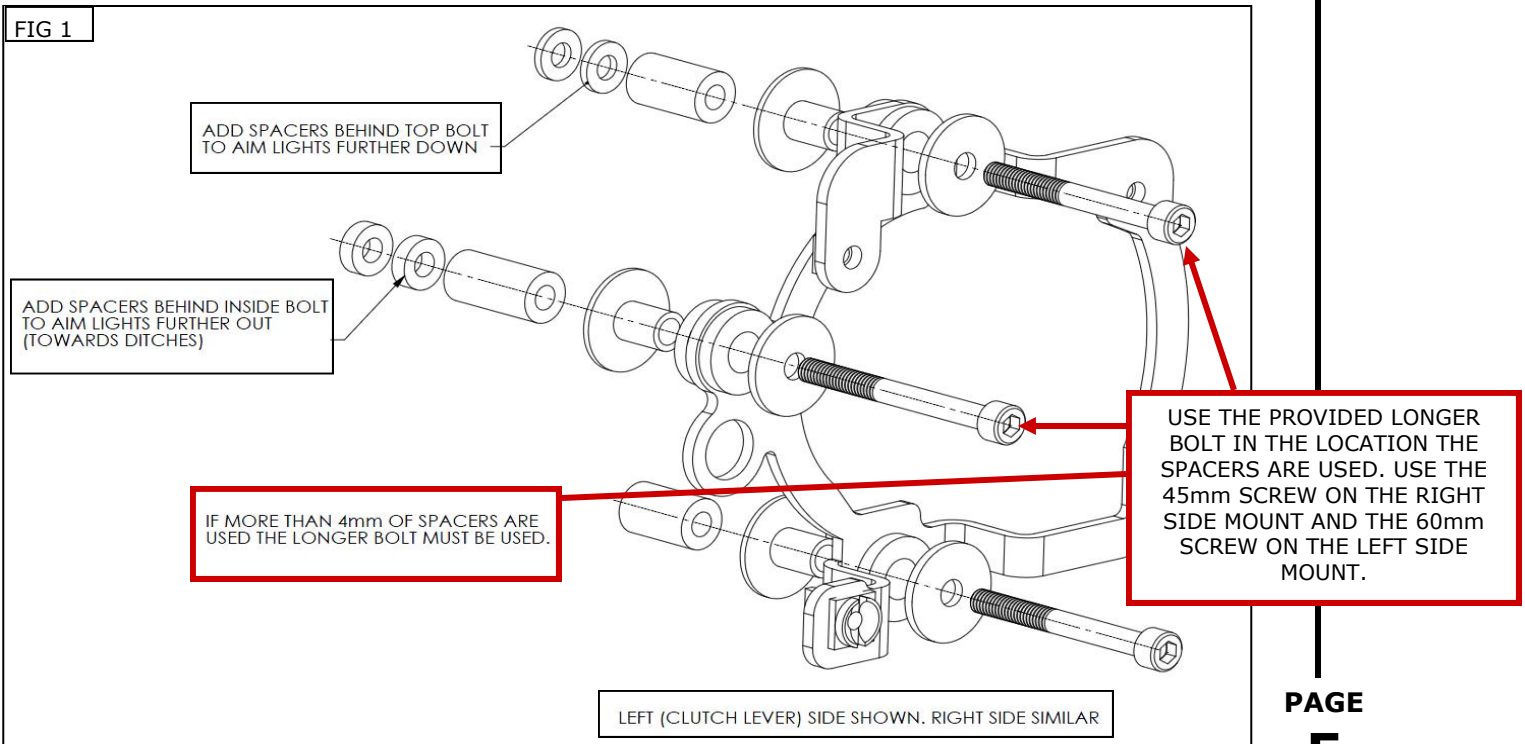

-cont.-

CLUTCH SIDE

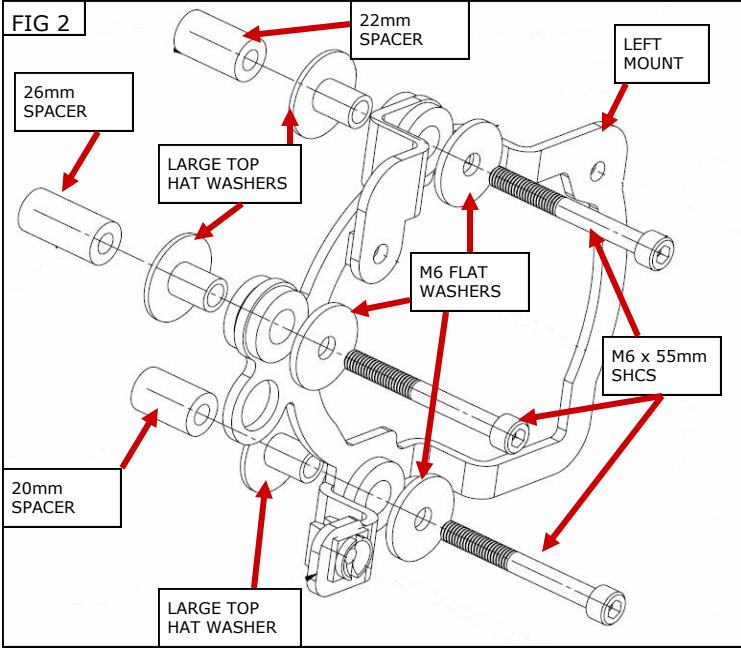

THROTTLE SIDE

